

A1 CD PRO

A1 SERIES TOP LOADING COMPACT DISC PLAYER

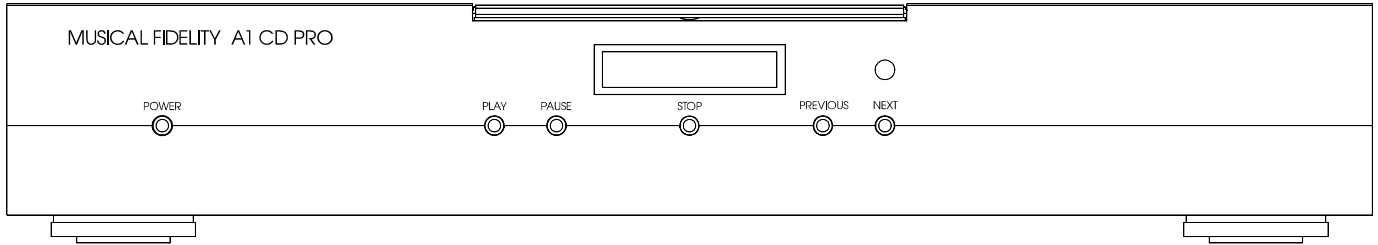

INSTRUCTIONS FOR USE

Thank you for purchasing the Musical Fidelity A1 CD PRO

This model uses a professional quality top-loading CD transport, ultra low jitter 24 Bit DAC technology and further jitter reduction techniques to achieve both an excellent technical specification and unparalleled CD sound quality.

The A1 is a perfect answer to CD requirements in a beautifully engineered package, complementing the A1 series components.

Used properly and carefully, it should give many years of outstanding musical reproduction.

Dust regularly with a soft duster or soft brush, but be careful when using cleaning or polishing agents - they may harm the surface finish.

*If you have any questions about your audio system,
Please consult your dealer who is there to help and advise.*

MUSICAL FIDELITY

PAGE		
3,4	Safety information	- Laser product labelling - Laser type - Radio-frequency interference
5	General advice	- Installation precautions - User information
6	Item disposal information	- EU disposal information
7	Installation	- Introduction - Installation - Audio connection - Notes on using compact discs - Cleaning
8,9	Facilities and connections	- Illustrations - front and rear panels
10	Remote control	- Operation and illustration
11,12	CD basic operation	- Loading, playback, and track selection
13,14	CD special features	- Repeat, shuffle, scan, programming
15	CD problems?	- Basic CD player fault finding
16	CD specifications	
17	Manual history	

CLASS 1 LASER PRODUCT

The A1 is a CD player which has been designed and manufactured according to FDA regulations "title 21, CFR, chapter 1, sub-chapter J, based on the Radiation Control for Health and Safety Act of 1968", and is classified as a Class 1 laser product. There is no hazardous radiation during normal use because invisible radiation emitted inside this product is completely confined within the protective housing. However you must observe the following important warnings:

CAUTION!

THIS CD PLAYER USES INVISIBLE LASER LIGHT. WHEN THE PLAYER OPERATES, LASER LIGHT IS RADIATED INTERNALLY. DO NOT REMOVE THE PROTECTIVE HOUSINGS.

USE OF CONTROLS OR ADJUSTMENTS OR PERFORMANCE OF PROCEDURES OTHER THAN THOSE SPECIFIED HEREIN MAY RESULT IN HAZARDOUS RADIATION EXPOSURE CAUSING EYE INJURY.

IF THIS PRODUCT DEVELOPS A FAULT, PLEASE CONTACT YOUR AUTHORISED MUSICAL FIDELITY SERVICE AGENT. DO NOT ATTEMPT TO SERVICE IT YOUR-SELF AND DO NOT CONTINUE TO USE THIS PRODUCT IN A FAULTY STATE.

INTERNAL LASER WARNING LABELS

**CAUTION!
CLASS 1
LASER
PRODUCT**

CAUTION - INVISIBLE LASER RADIATION WHEN OPEN AND INTERLOCKS DEFEATED. AVOID EXPOSURE TO BEAM.
VORSICHT! - UNSICHTBARE LASERSTRAHLUNG TRITTS AUS, WENN DECKEL GEÖFFNET UND WENN SICHERHEITVERRIEGELUNG ÖBERBRÖCT IST. NICHT DEM STRAHL AUSSETZEN!
VARNING - OSYNLIG LASERSTRALNING NÄR DENNA DEL ÄR ÖPPNAD OCH SPÄRR ÄR URKOPPLAD. STRALEN ÄR FARLIG.
ADVARSEL - USYNLIG LASERSTRÅLING VED ÅBNING, NAR SIKKERHEDSAFBRYDEREER UDE AF FUNCTION UDGÅ UDSÆTTELSE FOR STRÅLING.
VAROITUS! - SUOJAKOTELOA EI SAA AVATA LAITE SISÄLTÄÄ LASERDIODIN, JOKA LAHETTÄÄ (NAKYMATONTA) SILMILLE VAARALLISTA LASERSATEILYÄ.

REAR PANEL

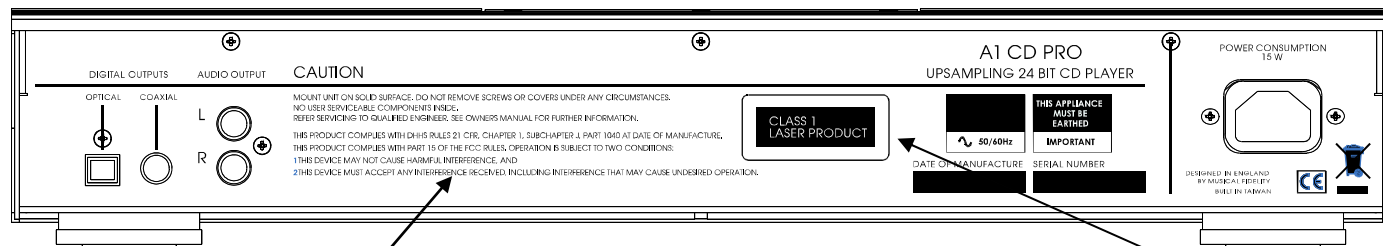

THIS PRODUCT COMPLIES WITH DHHS RULES 21 CFR, CHAPTER 1, SUBCHAPTER J, PART 1040 AT DATE OF MANUFACTURE.

THIS PRODUCT COMPLIES WITH PART 15 OF THE FCC RULES.

OPERATION IS SUBJECT TO TWO CONDITIONS:

- 1. THIS DEVICE MAY NOT CAUSE HARMFUL INTERFERENCE, AND**
- 2. THIS DEVICE MUST ACCEPT ANY INTERFERENCE RECEIVED, INCLUDING INTERFERENCE THAT MAY CAUSE UNDESIRED OPERATION.**

**CLASS 1
LASER PRODUCT**

LASER INFORMATION:

Optical pick-up :	Manufacturer : Sharp Pick-up type : GH6C005B Wavelength : 780nm
-------------------	---

RADIO - FREQUENCY INTERFERENCE (RFI)

This equipment uses and can radiate radio frequency energy, and if not installed and operated in accordance with the instructions, may cause interference to radio communications.

However, it is designed to radiate minimal levels of RFI, and accordingly been testing to North American standards (FCC regulations - limits for a class B digital device pursuant to part 15 of the rules). These requirements are intended to provide reasonable protection against excessive interference in a residential installation.

Conversely, the product has also been checked to ensure that its own operation is not adversely affected by normal background levels of RFI received externally.

However, if interference is experienced, for instance to radio or TV broadcasts, the user is recommended to try one or more of the following measures:

- Identify the source of interference by turning off power to the CD player or other equipment individually, and checking whether the problem disappears.
- Re-orientate or relocate the receiving aerial.
- Move the CD player away from the receiver.
- Connect the CD player to a mains outlet on a different circuit from the receiver.
- Consult a dealer or experienced TV/radio technician for help.

If a problem persists, please contact Musical Fidelity's service department.

INSTALLATION PRECAUTIONS and USER INFORMATION

Your new A1 is designed and built to provide trouble-free performance, but as with all electronic devices it is necessary to observe a few precautions:

Heed all warnings shown on the back of the product.

Only connect the A1 to a mains outlet having the same voltage as marked at the back of the unit.

Always ensure that when disconnecting and reconnecting your audio equipment the mains supply is switched off.

Position the mains lead and signal interconnects where they are not likely to be walked on or trapped by items placed on them.

Do not use near water, or place water-filled containers on the A1, for example, a flower vase or potted plants. **If water does spill inside, immediately pull out the mains plug from the wall socket and inform your dealer, who should then check the unit before further use. Entry of liquid into the A1 is dangerous, and may cause electric shock or fire hazard.**

Do not place the unit near direct heat sources such as radiators, direct sunlight or other equipment.

Do not remove any covers or try to gain access to the inside. There are no internal adjustments or fuses you can replace yourself. Refer all service work to an authorised Musical Fidelity agent.

Note: Unauthorised opening of the equipment will invalidate any warranty claim.

Dust regularly with a soft cloth or soft brush but be careful when using cleaning or polishing agents - they may harm the surface finish.

The electronics in modern hi-fi equipment is complex and may, therefore, be adversely affected or damaged by lightning. For protection of your audio system during electrical storms, remove the mains plugs and disconnect any aerial lead.

If after-sales service is required, to help your dealer identify the A1 please quote the serial number located on the rear panel of the unit.

**DISPOSAL**

The crossed out wheeled bin label that appears on the back panel of the product indicates that the product must not be disposed of as normal household waste. To prevent possible harm to the environment please separate the product from other waste to ensure that it can be recycled in an environmentally safe manner. Please contact your local government office or your retailer for available collection facilities.

**DISPOSITION**

La poubelle sur roulettes barrées X, qui apparaît en logo sur le panneau arrière du produit, indique que celui-ci ne doit pas être traité comme un déchet domestique commun. Afin de protéger l'environnement, ce produit électronique devra être géré séparément et donc recyclé selon les nouvelles normes Européennes Rohs concernant les déchets d'appareils électroniques. Prière de contacter les services concernés gouvernementaux ou votre point de vente pour l'élimination et l'enlèvement de déchets électroniques équipés de composants électroniques.

**DISPOSAL**

La etiqueta cruzada hacia fuera del compartimiento que aparece en el panel trasero del producto indica que el producto no se debe reciclar como basura normal de la casa. Para prevenir daños posible al ambiente separe por favor el producto de otras basura para asegurarse de que puede ser reciclada de una manera ambientalmente segura. Entre en contacto por favor a su oficina gubernamental local o a su minorista para las instalaciones disponibles de la colección.

**RIFIUTI**

L'etichetta del cassonetto barrato riportato sul retro dell'apparecchio indica che il prodotto non deve essere smaltito tramite la procedura normale di smaltimento dei rifiuti domestici. Per evitare eventuali danni all'ambiente, separare questo prodotto da altri rifiuti domestici in modo che possa venire riciclato in base alle procedure di rispetto ambientale. Per maggiori dettagli sulle aree di raccolta disponibili, contattate l'ufficio govenativo locale od il rivenditore del prodotto.

**FACHGERECHTE ENTSORGUNG:**

Das auf der Geräterückseite angebrachte Label deutet darauf hin, dass das Produkt nicht mit konventionellem Hauskehricht entsorgt werden darf. Um Schäden und Verschmutzungen an Umwelt und Mensch zu vermeiden, muss das Produkt fachgerecht entsorgt und von anderem Abfall getrennt werden. Wenden Sie sich bei Fragen hierzu an Ihren Fachhändler oder an eine öffentliche Informationsstelle.

AFVAL

Het label op de achterzijde van dit apparaat, een afvalbak op wielen met een kruis doorgehaald, geeft aan dat dit apparaat niet samen met gewoon huishoudafval mag worden weggegooid. Om mogelijke schade aan onze leefomgeving te voorkomen dient dit apparaat, gescheiden van gewoon huishoudelijk afval, te worden afgevoerd zodat het op een milieuvriendelijke manier kan worden gerecycled. Neem voor beschikbare inzamelplaatsen contact op met uw gemeentelijke reinigingsdienst of met uw elektronica leverancier.

**HÄVITTÄMINEN**

Yliüksattua jäteastiaa kuvaava tarra tuotteen takalevyssä kertoo, että tuotetta ei saa käsitellä normaalina talousjätteenä. Ympäristön suojelemiseksi on tuote pidettävä erillään muusta jätteestä ja se on kierrätettävä ekologisesti kestäväällä tavalla. Ota yhteyttä laitteen myyjään tai Pirkanmaan Ympäristökeskukseen lähimmän kierrätyskeskuksen löytämiseksi.

**AFSKAFNING**

Logoet med en skraldespand med kryds over på bagsiden af apparatet indikerer at dette produkt ikke må kasseres som normal husholdningsaffald. For at forebygge mulig skade på miljøet, bedes De separere dette produkt fra andet affald, og sikre at det bliver genbrugt på en miljørigtig måde. Kontakt venligst de lokale myndigheder eller din forhandler for oplysning om nærmeste tilgængelige opsamlingssted for elektronikaffald.

**ΔΙΑΔΙΚΑΣΙΑ ΑΠΟΡΡΙΨΗΣ**

ΤΟ ΣΗΜΑ ΜΕ ΤΟΝ ΔΙΑΓΕΓΡΑΜΜΕΝΟ ΤΡΟΧΗΛΑΤΟ ΚΑΔΟ ΑΠΟΡΡΙΜΑΤΩΝ ΣΤΗΝ ΠΙΣΩ ΟΨΗ ΤΟΥ ΜΗΧΑΝΗΜΑΤΟΣ ΔΗΛΩΝΕΙ ΟΤΙ ΤΟ ΠΡΟΙΟΝ ΑΥΤΟ ΔΕΝ ΠΡΕΠΕΙ ΝΑ ΔΙΑΧΕΙΡΙΣΘΕΙ ΣΑΝ ΣΥΝΗΘΙΣΜΕΝΟ ΟΙΚΙΑΚΟ ΑΠΟΒΛΗΤΟ. ΠΡΟΣ ΑΠΟΦΥΓΗ ΕΝΔΕΧΟΜΕΝΗΣ ΕΠΙΒΑΡΥΝΣΗΣ ΤΟΥ ΠΕΡΙΒΑΛΛΟΝΤΟΣ, ΞΕΧΩΡΙΣΤΕ ΤΟ ΠΡΟΙΟΝ ΑΠΟ ΤΑ ΑΛΛΑ ΑΠΟΡΡΙΜΑΤΑ ΩΣΤΕ ΝΑ ΕΞΑΣΦΑΛΙΣΘΕΙ Η ΑΝΑΚΥΚΛΩΣΗ ΤΟΥ ΜΕ ΤΟΝ ΠΡΕΠΟΝΤΑ ΤΡΟΠΟ. ΠΑΡΑΚΑΛΟΥΜΕ ΝΑ ΕΠΙΚΟΙΝΩΝΗΣΕΤΕ ΜΕ ΤΗΝ ΤΟΠΙΚΗ ΥΠΗΡΕΣΙΑ ΑΝΑΚΥΚΛΩΣΗΣ Η ΜΕ ΤΟ ΚΑΤΑΣΤΗΜΑ ΑΓΟΡΑΣ ΓΙΑ ΠΕΡΙΣΣΟΤΕΡΕΣ ΛΕΠΤΟΜΕΡΕΙΕΣ.

INTRODUCTION

Congratulations on the purchase of your new A1 CD player.

The A1 CD has extremely low jitter, vanishingly low distortion, exemplary linearity and ultra low noise. Its case design complements the A1 series components which include an integrated amplifier all in the same convenient size.

Great attention has been paid to internal layout, isolating each circuit section to prevent possible interaction.

For added convenience the front panel display and controls are duplicated on the top next to the mechanism. This allows easier track selection and control.

The CD digital data streams are first up-sampled to 192kHz, which moves noise, jitter and distortion artefacts well above the audio band. They are then passed through a new, low noise, low distortion 24-bit dual-differential digital-to-analogue converter, which allows simpler filtering of the analogue output. This in turn gives an improved audio response without the need for sharp filters that degrade sound quality. The result is a CD player which has a smoother response than previously possible with none of the "hardness" of other units.

The resultant performance achieved by this unit is among the best in the world. It has excellent signal to noise ratio, low distortion, wide bandwidth, huge dynamic range, extraordinary resolution and fine detail.

NOTES ON USING COMPACT DISCS

Always hold discs by the edges and make sure they remain clean - do not touch the surface. Keep discs away from direct sunlight and heat sources, such as radiators. Clean discs with a cloth before playing them, but do not use solvents such as benzene, thinners, or antistatic spray intended for analogue records.

After playing, always return the disc to its case for storage.

INSTALLATION

Position the A1 CD on a stable, horizontal surface where there is no risk of it being knocked, or subjected to vibration such as from loudspeakers.

Protect your A1 CD from humidity - if the unit is moved from a cold place to a warm room, or in generally humid conditions, moisture can form on the pickup lens inside the player, preventing the laser beam from reading the disc. If this happens, remove the CD, close the arm, and leave the unit switched on for an hour or so to allow sufficient time for the moisture to evaporate.

AUDIO CONNECTIONS

Outputs: Connect your amplifier inputs to the RCA sockets on the back panel marked as **LEFT** and **RIGHT** outputs.

If desired, the unit can also be attached to an external DAC of your choice. The unit outputs COAX and OPTICAL digital signal stream at 44.1kHz.

POWER CONNECTIONS

The unit plugs into mains supply using IEC mains lead.

The connector should fit comfortably when properly seated.

Do not force the connector.

SWITCHING ON

Press the front panel button. The display should light on the front panel, indicating the unit is ready to use.

CLEANING

Before cleaning the unit, switch off power at the mains switch and remove the mains plug from the wall socket.

Clean the cabinet and remote control unit using a moist cloth. We do not advise using solvents, white spirit or thinners as they could damage the surface finish.

FRONT PANEL

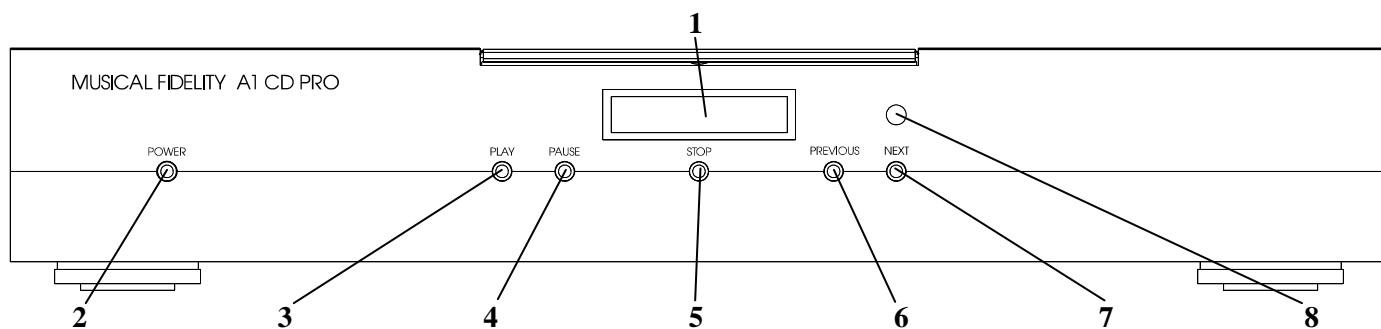

- 1. **DISPLAY**
- 2. **POWER** on/off switch
- 3. **PLAY** button
- 4. **PAUSE** button

- 5. **STOP** button
- 6. **PREVIOUS** button
- 7. **NEXT** button
- 8. **IR** lens

REAR PANEL

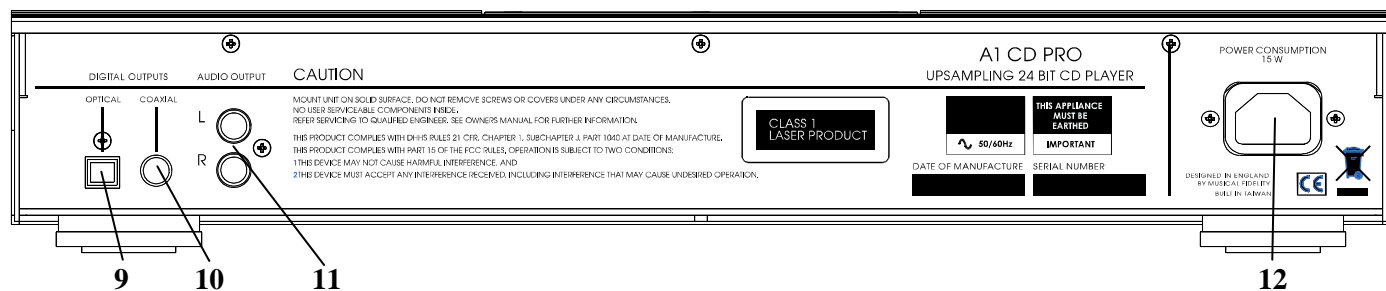

- 9. **DIGITAL OPTICAL** output
- 10. **DIGITAL COAXIAL** output

- 11. **LEFT AND RIGHT** audio outputs
- 12. **IEC MAINS** power connection

The universal remote control shown below enables functions from this and related units to be operated from a convenient distance. Equivalent buttons on the remote control have the same functions as those on the front panel of the unit. Other functions are only available by remote control.

As the handset uses an invisible infra-red light beam, the front edge must be pointed directly towards the receiver window at the front of the player, without visual obstruction between them.

If the range of the remote control greatly decreases, replace the batteries with new ones. Do not mix old and new batteries - two are required, size AAA, LR03 or SUM-4.

Please dispose of used batteries in accordance to local regulations.

Tuner Buttons:

INFO – To access broadcast information

MENU – to choose options

AUTO TUNE – finds previous/next broadcast

MONO/STEREO – Option for weaker FM stations

Amplifier Buttons:

PHONO – Selects Phono input

USB – Selects USB input

CD – Selects CD input

TUNER – Selects TUNER input

AUX/HT – Selects AUX 1/HT input

TAPE – Select TAPE input

CD Buttons:

TIME – Displays Track Time/Time remaining

0-9 Buttons – Used to select track numbers

CHECK – Check pre programmed tracks

PROGRAM – Programs selection and order of tracks

INTRO – Player plays first 10 seconds of each track

REPEAT – Repeats whole disk or selected tracks

SEARCH – Fast forward/backward through track

STOP – Stop playing/Eject CD



BAND – Selects DAB or FM

STORE – Stores station as preset

SELECT – To choose preset/DAB station

PRESET ↑ ↓ selects preset

TUNE ↑ ↓ steps up/down band

VOLUME UP/DOWN – sets volume level

MUTE – Mutes speaker outputs until pressed again

CLEAR – Clears selected pre programmed track

A/B Sets repeat start/end to repeat section of track

SHUFFLE – Plays back tracks in random order

TRACK – Next/previous track

PAUSE/PLAY – Stop/start CD playback

LOADING AND PLAYING COMPACT DISCS

NO DISC

To load a disc, manually lift the lid up from the front lip, to allow access to the mechanism.

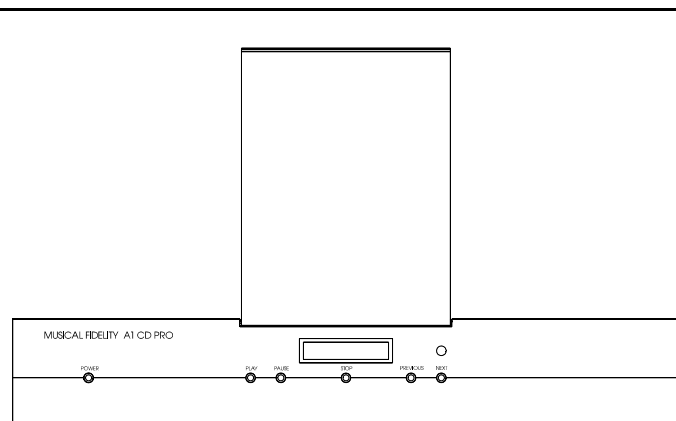

A1 with lid fully open to load/unload disk

OPEN

Displays will show "OPEN"

When the lid is fully extended, gently place the disc, with the label facing upwards, onto the spindle. Place magnetic puck onto spindle so it sits flat on the CD surface. Lower the lid again so the displays show "CLOSE".

CLOSE

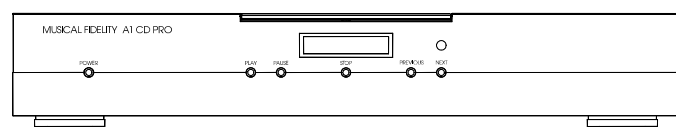

A1 with lid closed ready for playing

The unit will scan the contents of the disc. After a short delay, the display windows then show the total number of tracks available on the CD, and total playing time. In the following example there are 7 tracks, lasting a total of 41 minutes 56 seconds

STOP 7 41:56

If mains power to the unit is switched on with a disc already loaded, it will automatically search for the disc.

TRACK SELECTION (Remote control)

Simply press the **PLAY** button to start a CD playing from the first track.

Alternatively, a specific track can be selected directly by pressing one of the ten track number buttons grouped in the centre-section of the remote control. The chosen track then plays after a short delay of about 5 seconds. To play a track number with two digits, press the second digit button on the remote control within this delay period, example for track 17:

Press 1:

PLAY 1

Press 7 within about 5 seconds:

PLAY 17

After a small pause, machine plays selected track:

PLAY 17 0:01

If a track number is chosen which is not available on the disc, for example pressing button number 9 if the CD has only 7 tracks, an **INVALID TRACK** message is briefly displayed (along with elapsed time of last track played). The display then indicates **STOP**, and shows the number of tracks available on the CD and total playing time, as in the above example.

DISC PLAY

If **PLAY/PAUSE** is pressed, the unit will begin playing from track 1, confirmed by the word **PLAY** appearing on the left of the display, with **1** in the centre and elapsed time on the right.

PLAY 1 0:01

When all tracks on the CD have been played, the display shows **STOP** and total number of tracks on the disc.

PAUSE

Pressing the **PLAY/PAUSE** button on the front or top panel whilst a disc is playing pauses playback of the disc. **PAUSE** appears in the display windows instead of **PLAY**. The disc will continue spinning, but the track does not advance and the CD's output is muted.



Pressing **PLAY/PAUSE** again resumes playback from the same place.

PAUSE (Remote control)

On the remote control, **PLAY** and **PAUSE** buttons have separate functions at each end of the same button. Pressing **PLAY** will only control disc play, and Pressing **PAUSE** will not resume play. Note that if the disc is already playing, pressing the **PLAY** button reverts to the beginning of the current track.

STOP

Playback can be stopped at any time by pressing the **STOP** button once. On the remote control, press either end of the button, not the middle part.



TRACK SELECTION

To change track, the track skip buttons **PREVIOUS** and **NEXT** on the front panel can be pressed to jump forwards or backwards one track in either direction.

Corresponding **TRACK** buttons on the remote control are marked |<< and >>|.

If the unit has stopped playing, a specific track can be accessed directly by pressing either **PREVIOUS** or **NEXT** to obtain the required track number, then pressing **PLAY/PAUSE**.

REPEAT PLAYBACK

The **REPEAT** button on the remote control allows the repeated playback of either one track or all tracks on the disc.

By pressing the **REPEAT** button once, only the current track is repeated, and the display shows



If the **REPEAT** button is pressed a second time, "repeat disc" is displayed instead, and the entire disc is then played repeatedly.



Pressing **REPEAT** a third time cancels repeat mode.

A-B REPEAT PLAYBACK

"A-B repeat" provides the option of playing just a certain section of the disc over and over again.

Find the beginning of the required section either by listening, or using the display time as a guide.

When the desired starting point is reached, press button **A / B** on the remote control.

The display will show



When the disc has reached the end of the required section, press the **A / B** button again, to display and the unit



continuously plays the selected part of the disc in this case, the segment of track 1 from 34 seconds to 1 minute 55 seconds.

To cancel A-B repeat mode, press **A / B** on the remote control.

SHUFFLE PLAYBACK

The **SHUFFLE** feature allows tracks on the discs to be played in random sequence rather than the normal consecutive order.



Tracks are also played in a different order each time the disc is restarted, or another disc loaded.

This function is obtained by pressing **SHUFFLE** on the remote control with the unit either stopped or playing. If the A1 is already playing, play will continue in random order until all tracks on the disc have been played.

Shuffle play is cancelled by pressing the **SHUFFLE** button a second time. The unit resumes normal play function, continuing to the end of the disc in normal order starting from wherever it was left by the previous random selection.

From stop mode, pressing **PLAY/PAUSE** also begins shuffle play.

If **REPEAT** is then pressed whilst in shuffle mode, a repeat shuffle function is obtained



Pressing >>| selects the next track in random order.

SCAN INTRODUCTION

The scan-introduction function allows play back of just the start of each track on the disc, for instance to locate a preferred track by ear.

Press **INTRO** on the remote control, and if the player has stopped, the display will show



The first ten seconds (approximately) of each track on the CD can then be played in sequence by pressing either **PLAY/PAUSE** on the front panel, or **PLAY** on the remote control.

Press **INTRO** again to cancel introduction search mode.

If **INTRO** mode is cancelled while the A1 is still playing, the remainder of the entire disc will be played.

PROGRAMMED PLAY

The built-in program memory allows you to store up to 25 track numbers and then play them back in the held order. Each track is stored as a "step" in the program.

With the CD loaded and the player stopped, first press **PROGRAM** on the remote control. The following is then displayed :



On the remote control, press the numeric button of the track number corresponding to the first track you wish to store (number 3 for example). That track number will now appear in the display:

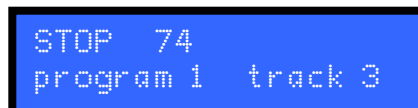

Press **PROGRAM** again on the remote control - the next program step is selected, (**program 2**) and the track number revert to 0 ready for a new entry.



STOP 74
program 2 track 0

Continue entering track numbers in the same way up to a maximum of 25. If more than 25 tracks are attempted the memory will not accept any extra ones, and the display reverts to "**program 1**".

Remember that when entering a single-digit track number, there is a delay of about two seconds before the display accepts the entry - this is to allow time for a second button to be pressed when a double-digit number is required.

If an incorrect entry is made, say track 99 when there are only 7 tracks available on the disc, a brief error message is displayed



INVALID TRACK
program 2 track 9

If at any time you wish to add a track to the list, press the **CLEAR** button to obtain the next step number. Alternatively, to delete a previous entry, press **CLEAR** a second time to remove the last entry. Repeated pressing of **CLEAR** will then erase each step in reverse order. So to delete an entire program sequence from the memory, press **CLEAR** repeatedly until "**program 1**" is shown in the display.

When the last track number has been entered, press **PROGRAM** a final time, then the **PLAY** button to start the program sequence.



PLAY 1 0:41
play program

If you wish to check the selection before playing back your program, the **CHECK** button can be pressed to step through each program entry in turn.

If during this check sequence the **PLAY** button is pressed, the remaining part of your programmed selection will play to the end of the sequence.

Otherwise, to play all the programmed tracks from the beginning of the sequence, press **PLAY/PAUSE**, or **PLAY** on the remote control.

The **>>|** button may be pressed to jump to the next track in the programmed sequence, or **|<<** button to obtain the previous track in the sequence.

When all programmed tracks have been played, the CD player stops. The same track selection can then be played again by pressing the **PLAY/PAUSE** button on the front panel, or **PLAY** on the remote control.

To repeat a programmed sequence continually, press **REPEAT** whilst playing the program.

To cancel this mode, press **PROGRAM**.

Note: The program contents will be cleared if you switch off the power, or open the lid and load another disc. If, however, the same disc is loaded again with the power still switched on, the program sequence is retained in the memory.

Basic problem-solving with a CD player is similar to troubleshooting other electrical or electronic equipment. Always check the most obvious possible causes first, such as the following examples:

Problem	Probable Cause	Remedy
No power / display	Power plug is not inserted correctly	Plug in securely into A1 IEC socket
No playback when disc is loaded, "NO DISC" displayed	Disc is loaded with label side down Incorrect disc type Dirty disc Moisture/humidity or cold affecting laser lens	Re-load with label side up Please load a standard audio CD Clean disk and try again Leave unit on for an hour to allow moisture to evaporate.
No audio output, or too low level output	Incorrect or missing connections	Check connections and make sure they are secure.
Hum	Audio connector plug not fully pushed in Cable Fault Unsuitable Cable (e.g. cable grounds not connected)	Insert plug securely Check cable is connected at both ends. N.B. some esoteric cables have internal wiring intentionally disconnected/modified. For best results on all inputs analogue AND digital, please use good quality screened coax; signal and screen directly connected both ends.
Miss-tracking (sound jumping)	Magnetic puck not present or not mounted correctly Player is receiving vibration or shock Disc is dirty Moisture/humidity or cold affecting laser lens.	Check puck is present and correctly positioned. Change position of player away from loudspeakers Clean disc surface Leave unit on for an hour to allow moisture to evaporate.
Interference noise heard from radio tuner	Player is positioned too near the tuner	Keep a reasonable distance between player and tuner, or switch off player power
Remote control does not work	Power supply switch is set to off	Set switch to on
	Battery(ies) fitted the wrong way round	Insert batteries correctly
	Batteries are flat	Change batteries for a new set
	Remote control is not pointed directly towards the front panel of the player	Ensure there is no obstruction between the remote control and player front
Remote control range has greatly reduced	Batteries are running out	Change batteries – for a new set



This product contains a PHILIPS CD mechanism, which complies with the PHILIPS/SONY red book CDDA standard. It is guaranteed to play all disks similarly marked without any problems.

Please note that due to "piracy" concerns, some record companies/pressing plants are creating disks that do not adhere to this standard. Such disks may –or– may not play in some –or– all CD player products of any manufacturer. We advise caution in using these disks, as the information contained therein has been deliberately manipulated and can cause audio degradation and/or playability problems.

We also advise caution with using cheap CD-R, and/or CD-RW disks for audio, and to ensure all home-generated CDs intended for playback on this unit are recorded as CDDA AUDIO CDs (i.e. not MP3, WAV, AAC etc.) on good quality media.

Remember - the most vulnerable part of a CD playing system is the disc itself. The most likely cause of a disc not playing is that the disc itself is faulty, scratched or simply dirty. Never open the case of the unit yourself, as this will invalidate the guarantee. If none of the above actions affect a cure, please contact your dealer or Musical Fidelity service agent.

DAC:	Output impedance	50 Ohms	
	DAC circuit	24 bit Delta-Sigma (Bit stream) dual differential 8X over sampling	
	Total correlated jitter	< 135 pS	
	Linearity	< 0.1dB down to -96dB	
	Output digital 0dB level	2.18VRMS at 1 kHz nominal	
	Frequency response	10Hz to 20 kHz -0.2dB max	
	Channel separation	> 105dB 20Hz to 20 kHz	
	Signal / noise ratio	> 117dB "A" weighted	
	Total harmonic distortion	< 0.003% 10Hz to 20 kHz	
Connections:	Line level outputs:	1 pair RCA outputs	
	Digital outputs	1 S/PDIF (RCA connector) 1 optical (TOSLINK)	
Power requirement:	100 / 115 / 230Volts AC 50 / 60Hz (factory pre-set),	15 Watts maximum	
Standard accessories:	A1 Power supply lead	1.0 m 39 ¼ inches	1 off
	Mains lead	10 Amp IEC type	1 off
	Remote control	A1, universal	1 off
	Magnetic puck	Disk clamping puck	1 off
	Batteries	Size LR03 or AAA manganese alkaline type	2 off
Dimensions:	Main unit		
	440 mm	17⅓ inches	wide
	78 mm	3 inches	high inc. feet, lid closed
	280mm	11 inches	(250mm [9 ¾ inches] minimum height clearance required to fully open lid) deep inc. terminals
Weight:	10.1 kg,	22¼ lbs	Unboxed
	12.6 kg	27 ¾ lbs	Boxed unit including all accessories

Musical Fidelity reserves the right to make improvements which may result in specification or feature changes without notice.



RELEASE	DATE	CHANGES
Issue 1	28 th January 2008	1 st release
Issue 2	11 th March 2008	Remote control page updated
Issue 3	30 th April 2008	Magnetic puck added
Issue 4	6 th May 2008	Specification page updated