

FULLY
BALANCED
PREAMPLIFIER

| M8PRE

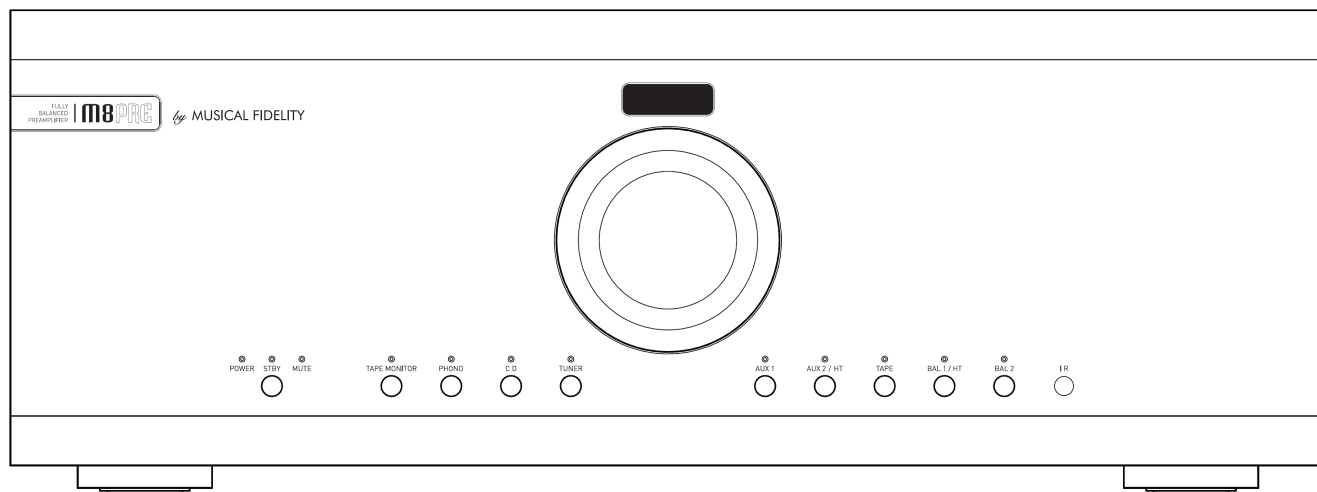

Instructions for use

Thank you for purchasing the Musical Fidelity M8 Preamp fully balanced dual mono pre-amplifier.

This preamp is designed with high quality control and especially balanced sources in mind.

Two balanced (XLR) inputs take care of balanced audio for the best in signal to noise, transient reproduction and dynamic range from balanced sources. Inside, the balanced signal path is fully maintained, from input to output, with a specially developed dual mono fully balanced preamp circuit.

The balanced volume control is a quad laser-trimmed attenuator giving 0.5dB steps of perfect matching, allowing precise stereo imaging and ultra-low noise and distortion. The outputs are also balanced allowing connection of balanced input power amplifiers to realise a completely balanced system from source to speakers.

Units with single – ended (RCA) inputs and outputs are catered for with 6 selectable RCA inputs, and two sets of outputs, one fixed for recording, etc, the other is the main controlled output.

The M8 Preamp has been designed to mix-and-match input/output signal types and use the unit as a single ended to balanced (or vice versa) converting preamp. It is also designed to allow use of both balanced and single ended outputs, simultaneously, if required.

All conversions are carried out automatically within the unit, all that needs to be done is choose and connect the correct input and output leads.

The M8 Preamp is designed to be partnered with present and future M8 or M6 series products or alternatively, may be used with any other high quality hi-fi components. This combination yields one of the best high-fidelity systems available at any price.

Used properly and carefully, it should give many years of outstanding musical reproduction.

Dust regularly with a soft duster or soft brush, but be careful when using cleaning or polishing agents - they may harm the surface finish.

If there are any questions about the audio system, please consult the dealer who is there to help and advise.

Section	Page
Safety Information	3
– Mains plug (UK only)	
– Modification warning	
General advice	4
– Installation precautions & user information	
Disposal information	5
– EU disposal information	
Installation	6
– Introduction, cleaning, installation, power connections, audio connections	
Facilities and connections	7
– Illustrations, main unit front & rear panels	
Remote control handset	8
– Operation and illustration	
Operation	9
– Starting,	
– Volume	
– Mute	
– PHONO	
– CD	
– TUNER	
– AUX1	
– AUX2/HT	
– TAPE	10
– TAPE MONITOR	
– BALANCED 1/HT	
– BALANCED 2	
Problems?	11
– Basic fault finding	
Specifications	12
Manual history	13

IMPORTANT! (U.K. only)

This unit is supplied in the U.K. with mains lead fitted with a moulded 13 amp plug. If, for any reason, it is necessary to remove the plug, please remove the fuse holder and dispose of the plug safely, out of reach of children.

It must not be plugged into a mains outlet.

The wires in the mains lead supplied with this appliance are coloured in accordance with the following code:

Green and yellow..... Earth
Blue..... Neutral
Brown Live

WARNING – This appliance MUST be earthed

As the colours of the wires of the mains lead of this appliance may not correspond with the coloured markings identifying the terminals in the plug, proceed as follows:

- The wire which is coloured green-and-yellow must be connected to the terminal in the plug which is marked with the letter E or coloured green or green-and-yellow, or by the earth symbol: 
- The wire which is coloured brown must be connected to the terminal which is marked with the letter L or coloured red.
- The wire which is coloured blue must be connected to the terminal which is marked with the letter N or coloured black.
- If connecting to a BS1363 plug, a 13 amp fuse must be used.

WARNING:
ANY MODIFICATIONS TO THIS PRODUCT NOT EXPRESSLY APPROVED BY MUSICAL FIDELITY WHO IS THE PARTY RESPONSIBLE FOR STANDARDS COMPLIANCE COULD VOID THE USER'S AUTHORITY TO OPERATE THIS EQUIPMENT.

Installation precautions & user information

This new M8 Preamplifier is designed and built to provide trouble-free performance, but as with all electronic devices it is necessary to observe a few precautions:

- Heed all warnings shown on the back of the product.
- Only connect the M8 Preamplifier to a mains outlet having the same voltage as marked at the back of the unit.
- Always ensure that when disconnecting and reconnecting your audio equipment the mains supply is switched off.
- Position the mains lead and signal interconnects where they are not likely to be walked on or trapped by items placed on them.
- Do not use near water, or place water-filled containers on the M8 Preamplifier, for example, a flower vase or potted plants. **If water does spill inside, immediately pull out the mains plug from the wall socket and inform your dealer, who should then check the unit before further use. Entry of liquid into the M8 Preamplifier is dangerous, and may cause electric shock or fire hazard.**
- Do not place the unit near direct heat sources such as radiators, direct sunlight or other equipment.
- Do not remove any covers or try to gain access to the inside. There are no internal adjustments or fuses you can replace yourself. Refer all service work to an authorised Musical Fidelity agent.
*** Note: Unauthorised opening of the equipment will invalidate any warranty claim.**
- Dust regularly with a soft cloth or soft brush but be careful when using cleaning or polishing agents - they may harm the surface finish.

The electronics in modern hi-fi equipment is complex and may, therefore, be adversely affected or damaged by lightning. For protection of the audio system during electrical storms, remove the mains plugs.

If after-sales service is required, to help the dealer identify the M8 Preamplifier please quote the serial number located on the rear panel of the unit.

**DISPOSAL**

The crossed out wheeled bin label that appears on the back panel of the product indicates that the product must not be disposed of as normal household waste. To prevent possible harm to the environment please separate the product from other waste to ensure that it can be recycled in an environmentally safe manner. Please contact local government office or retailer for available collection facilities.

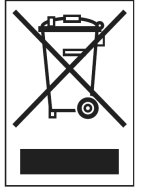
**DISPOSITION**

La poubelle sur roulettes barrées X, qui apparaît en logo sur le panneau arrière du produit, indique que celui-ci ne doit pas être traité comme un déchet domestique commun. Afin de protéger l'environnement, ce produit électronique devra être géré séparément et donc recyclé selon les nouvelles normes Européennes Rohs concernant les déchets d'appareils électroniques. Prière de contacter les services concernés gouvernementaux ou votre point de vente pour l'élimination et l'enlèvement de déchets électroniques équipés de composants électroniques.

**DISPOSAL**

La etiqueta cruzada hacia fuera del compartimiento que aparece en el panel trasero del producto indica que el producto no se debe reciclarse como basura normal de la casa. Para prevenir daños posible al ambiente separe por favor el producto de otras basura para asegurarse de que puede ser reciclada de una manera ambientalmente segura. Entre en contacto por favor a su oficina gubernamental local o a su minorista para las instalaciones disponibles de la colección.

**RIFIUTI**

L'etichetta del cassonetto barrato riportato sul retro dell'apparecchio indica che il prodotto non deve essere smaltito tramite la procedura normale di smaltimento dei rifiuti domestici. Per evitare eventuali danni all'ambiente, separare questo prodotto da altri rifiuti domestici in modo che possa venire riciclato in base alle procedure di rispetto ambientale. Per maggiori dettagli sulle aree di raccolta disponibili, contattate l'ufficio govenativo locale od il rivenditore del prodotto.

**FACHGERECHTE ENTSORGUNG:**

Das auf der Geräterückseite angebrachte Label deutet darauf hin, dass das Produkt nicht mit konventionellem Hauskehricht entsorgt werden darf. Um Schäden und Verschmutzungen an Umwelt und Mensch zu vermeiden, muss das Produkt fachgerecht entsorgt und von anderem Abfall getrennt werden. Wenden Sie sich bei Fragen hierzu an Ihren Fachhändler oder an eine öffentliche Informationsstelle.

**AFVAL**

Het label op de achterzijde van dit apparaat, een afvalbak op wielen met een kruis doorgehaald, geeft aan dat dit apparaat niet samen met gewoon huishoudafval mag worden weggegooid. Om mogelijke schade aan onze leefomgeving te voorkomen dient dit apparaat, gescheiden van gewoon huishoudelijk afval, te worden afgevoerd zodat het op een milieuvriendelijke manier kan worden gerecycled. Neem voor beschikbare inzamelplaatsen contact op met uw gemeentelijke reinigingsdienst of met uw elektronica leverancier.

**HÄVITTÄMINEN**

Yliuksattua jäteastiaa kuvaava tarra tuotteen takalevyssä kertoo, että tuotetta ei saa käsitellä normaalina talousjätteenä. Ympäristön suojelemiseksi on tuote pidettävä erillään muusta jätteestä ja se on kierrätettävä ekologisesti kestävällä tavalla. Ota yhteyttä laitteen myyjään tai Pirkanmaan Ympäristökeskukseen lähimmän kierrätyskeskuksen löytämiseksi.

**AFSKAFNING**

Logoet med en skraldespand med kryds over på bagsiden af apparatet indikerer at dette produkt ikke må kasseres som normal husholdningsaffald. For at forebygge mulig skade på miljøet, bedes De separere dette produkt fra andet affald, og sikre at det bliver genbrugt på en miljørigtig måde. Kontakt venligst de lokale myndigheder eller din forhandler for oplysning om nærmeste tilgængelige opsamlingssted for elektronikaffald.

**ΔΙΑΔΙΚΑΣΙΑ ΑΠΟΡΡΙΨΗΣ**

ΤΟ ΣΗΜΑ ΜΕ ΤΟΝ ΔΙΑΓΕΓΡΑΜΜΕΝΟ ΤΡΟΧΗΛΑΤΟ ΚΑΔΟ ΑΠΟΡΡΙΜΑΤΩΝ ΣΤΗΝ ΠΙΣΩ ΟΨΗ ΤΟΥ ΜΗΧΑΝΗΜΑΤΟΣ

ΔΗΛΩΝΕΙ ΟΤΙ ΤΟ ΠΡΟΙΟΝ ΑΥΤΟ ΔΕΝ ΠΡΕΠΕΙ ΝΑ ΔΙΑΧΕΙΡΙΣΘΕΙ ΣΑΝ ΣΥΝΗΘΙΣΜΕΝΟ ΟΙΚΙΑΚΟ ΑΠΟΒΛΗΤΟ. ΠΡΟΣ ΑΠΟΦΥΓΗ ΕΝΔΕΧΟΜΕΝΗΣ ΕΠΙΒΑΡΥΝΣΗΣ ΤΟΥ ΠΕΡΙΒΑΛΛΟΝΤΟΣ, ΞΕΧΩΡΙΣΤΕ ΤΟ ΠΡΟΙΟΝ ΑΠΟ ΤΑ ΑΛΛΑ ΑΠΟΡΡΙΜΑΤΑ ΩΣΤΕ ΝΑ ΕΞΑΣΦΑΛΙΣΘΕΙ Η ΑΝΑΚΥΚΛΩΣΗ ΤΟΥ ΜΕ ΤΟΝ ΠΡΕΠΟΝΤΑ ΤΡΟΠΟ. ΠΑΡΑΚΑΛΟΥΜΕ ΝΑ ΕΠΙΚΟΙΝΩΝΗΣΕΤΕ ΜΕ ΤΗΝ ΤΟΠΙΚΗ ΥΠΗΡΕΣΙΑ ΑΝΑΚΥΚΛΩΣΗΣ Η ΜΕ ΤΟ ΚΑΤΑΣΤΗΜΑ ΑΓΟΡΑΣ ΓΙΑ ΠΕΡΙΣΣΟΤΕΡΕΣ ΛΕΠΤΟΜΕΡΕΙΕΣ.

Introduction

Congratulations on the purchase of the new M8 Preamplifier. Great attention has been paid to internal layout, isolating each circuit section to prevent possible interaction.

The unit features a high precision fully balanced preamplifier, for smooth sound coupled with low noise and virtually no distortion.

The preamplifier consists of two monoblock balanced amplifiers with generously rated supplies for the absolute best in separation and imaging. Low distortion and very quiet they will deliver all music types exactly as the artist originally intended.

The resultant performance achieved by this unit is among the best in the world. It has excellent signal to noise ratio, low distortion, wide bandwidth and dynamic range, with extraordinary resolution and fine detail.

Cleaning

Before cleaning the unit, switch off power at the mains switch and remove the mains plug from the wall socket.

Clean the cabinet and remote control unit using a moist cloth. Using solvents, white spirit or thinners is not advised, as they could damage the surface finish.

Installation

Position the M8 Preamplifier on a stable, horizontal surface where there is no risk of it being knocked, or subjected to vibration such as from loudspeakers.

Important note:

The M8 Preamplifier must be protected from humidity – if the unit is moved from a cold place to a warm room, leave the unit for an hour or so to allow sufficient time for the moisture to evaporate.

Power Connections

The M8 Preamplifier is supplied with a standard IEC mains cable which plugs into the IEC socket at the back of the unit (see page 7)

Audio Connections

RCA Inputs: Connect all RCA single-ended sources to relevant analogue inputs (see page 7 for more information). Use good quality fully connected (signal and ground) coaxial phono cables for all RCA signal connections.

XLR Inputs: Connect any XLR balanced source to desired balanced analogue inputs (see page 7 for more information). Use good quality fully connected (signals and ground) balanced XLR cables for all XLR signal connections.

Phono Input: Connect a turntable with MM or MC type cartridge to the M8 Preamplifier phono input to allow audio from turntable to be heard through the hi-fi. Use a good quality well-screened phono cable for very best results. *Keep the phono leads as far away as possible from mains leads, plugs and sockets to avoid unwanted hum pickup!*

TAPE Output: Direct loop through of *selected* source. The level of this output is unaffected by the volume control, to pass on to a recorder or other equipment. It is also the ideal output for standalone headphone amplifiers (incorporating their own volume control).

RCA Outputs: Connect all RCA single-ended power amplifier(s) to RCA analogue outputs (see page 7 for more information). Use good quality fully connected (signal and ground) coaxial phono cables for all RCA signal connections.

XLR Outputs: Connect any XLR balanced power amplifier(s) to XLR analogue outputs (see page 7 for more information). Use good quality fully connected (signals and ground) balanced XLR cables for all XLR signal connections.

Please note: Musical Fidelity currently do not make any interconnecting cables, nor do we endorse any particular manufacturer's cables. If required, please refer to the Musical Fidelity dealer who can give up to date advice on good quality cables for any particular setup.

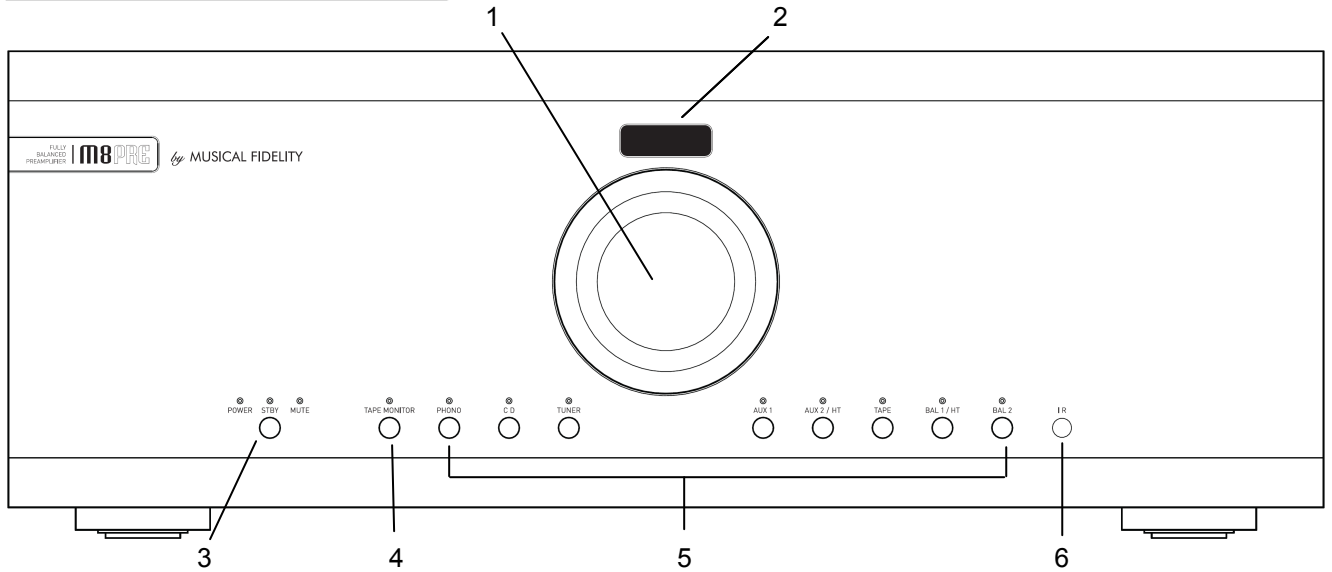

- 1 **VOLUME** control
- 2 **VOLUME** display (in decibels)
- 3 **ON/OFF** Button
- 4 **TAPE MONITOR** button
- 5 **PHONO, CD, TUNER, AUX/HT, TAPE** **BALANCED 1/HT, BALANCED 2** input selector buttons
- 6 **IR RECEIVER** lens

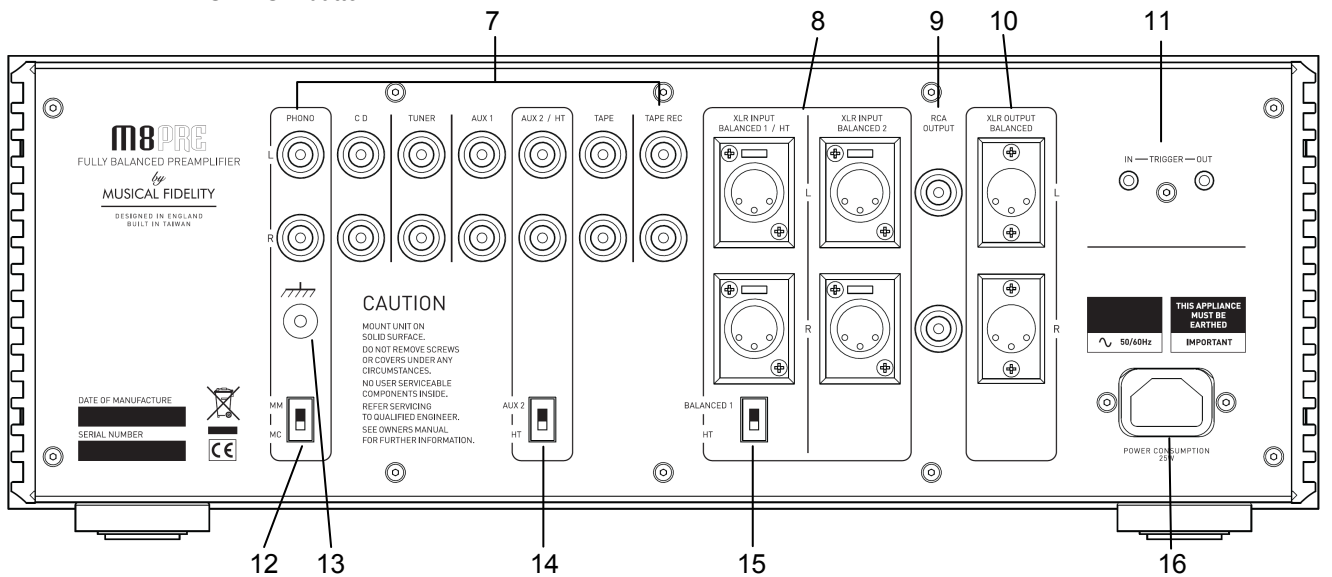

- 7 **PHONO CD, TUNER, AUX/HT** RCA left and right inputs
- 8 **XLR BALANCED 1/HT & 2** right and left inputs
- 9 **RCA** main outputs left and right
- 10 **XLR BALANCED** main outputs left and right
- 11 **TRIGGER IN/OUT** 3.5mm mono jack sockets
- 12 **PHONO MM/MC** switch
- 13 **GROUND** post for turntable
- 14 **HT/AUX** Selector for HT/AUX inputs
- 15 **BALANCED HT/AUX** Selector for XLR balanced input 1/HT
- 16 **IEC MAINS INPUT**

XLR Balanced input and output lead connections:

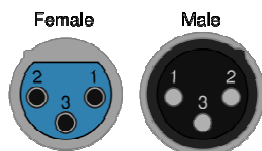

(for reference, no XLR signal leads supplied)

Pin functions:

- 1 Ground (cable shield)
- 2 Normal polarity ("hot" or "+")
- 3 Inverted polarity ("cold" or "-")

REMOTE CONTROL HANDSET

The universal remote control shown below enables functions from this and related units to be operated from a convenient distance.

Equivalent buttons on the remote control have the same functions as those on the front panel of the unit. Other functions are only available by remote control.

As the handset uses an invisible infra-red light beam, the front edge must be pointed directly towards the receiver window at the front of the player, without visual obstruction between them.

If the range of the remote control greatly decreases, replace the batteries with new ones. Do not mix old and new batteries – two are required, size AAA, LR03 or SUM-4.

Please dispose of used batteries in accordance to local regulations.

Amplifier section

DISPLAY – dims display

PHONO - selects phono input

CD - selects CD input (on amplifier)

AUX1- selects AUX1 input

AUX2/HT - selects AUX/HT input

BAL 1 /HT- selects balanced1/HT input

BAL 2 - selects balanced 2 input

CD Player DAC-input section

SPDIF – selects COAX input

OPTICAL – selects OPTICAL input

DISPLAY – dims display

0-9 Buttons – Used to select track numbers

CHECK – check pre-programmed tracks

PROGRAM – programs selection and order of tracks

INTRO – plays first 10 seconds of each track

REPEAT – repeats whole disk or selected tracks

SEARCH – fast forward/backward through track

STOP – Stop playing/Eject CD



MUTE - mutes Preamp outputs (until pressed again).

TUNER - selects TUNER input

VOLUME ▲ - increases volume

VOLUME ▼ - reduces volume

TAPE - selects TAPE input

CD – Selects CD player internal mechanism

AES-USB – selects XLR input or USB input (CD player dependant)

TIME – displays track time/time remaining

CLEAR – clears selected pre programmed track

A/B sets repeat start/end to repeat section of track

SHUFFLE – plays back tracks in random order

TRACK – next/previous track

PAUSE/PLAY – stop/start CD playback

Starting

Once all connections are made, switch on the unit, using the **POWER** button front of the unit. The **MUTE** LED will light. Outputs are muted for about 6 seconds, so no sound will be heard. Once the 6 seconds is up the **MUTE** LED goes out, indicating unit is settled, and ready for use.

Volume

The volume should be adjusted for normal listening levels. This is done by turning the volume up/down knob on the front panel. Adjusting the volume can also be achieved using the remote handset, using the volume up/down buttons (see page 8).

The red LED display shows the current dB step of the laser-trimmed electronic attenuator. The display increments by accurate 0.5dB steps.

Note: above 99.5dB, the "0.5" digit is no longer visible, but each attenuator step remains as 0.5dB, so it takes two 0.5dB steps or clicks on the volume control to update the display by 1dB.

Mute (Remote Control only)

The output may be muted by use of the **MUTE** button on the remote. Press once, and **MUTE** LED will light indicating muted state. No sound will be heard from the speakers.

To return to listening; simply press the **MUTE** button again so **MUTE** LED is no longer lit.

PHONO input

To use the **PHONO** input, connect record deck outputs to the **PHONO** input RCA sockets (see page 7). Set the correct cartridge type using the **MM/MC** switch under the RCA input plugs. Select **PHONO** input by pressing the **PHONO** button so **PHONO** LED is lit.

Selecting the **PHONO** input can also be achieved by pressing the corresponding button on the remote handsets (see page 8).

CD input

To use the **CD** input, connect CD player outputs to the **CD** input RCA sockets (see page 7). Select **CD** input by pressing the **CD** button so **CD** LED is lit.

Selecting the **CD** input can also be achieved by pressing the corresponding button on the remote handsets (see page 8).

TUNER input

To use the **TUNER** input, connect tuner outputs to the **TUNER** input RCA sockets (see page 7). Select **TUNER** input by pressing the **TUNER** button so **TUNER** LED is lit.

Selecting the **TUNER** input can also be achieved by pressing the corresponding button on the remote handset (see page 8).

AUX1 input

To use the **AUX1** input, connect tuner outputs to the **AUX1** input RCA sockets (see page 7). Select **AUX1** input by pressing the **AUX1** button so **AUX1** LED is lit.

Selecting the **AUX1** input can also be achieved by pressing the corresponding button on the remote handset (see page 8).

AUX2/HT input

To use the **AUX** input as a standard input, move the AUX/HT switch on the back panel to the AUX position. Connect source outputs to the **AUX** input RCA sockets (see page 7). Select **AUX** input by pressing the **AUX** button so **AUX** LED is lit. Selecting the **AUX** input can also be achieved by pressing the corresponding button on the remote handset, (see page 8).

To use the AUX/HT input as an HT input, move the AUX/HT switch to the HT position. This input is now unaffected by the volume control, allowing volume control on an external Home Theatre processor to be used directly. Connect Home theatre or other source outputs to the **AUX** input RCA sockets (see page 7). Select **AUX** input by pressing the **AUX** button so **AUX** LED is lit.

***IMPORTANT:** Take great care when using the input in HT mode. Ensure that the volume control is turned right down on the HT processor when first setting up. The HT mode is designed for sources which require their own volume control to be used. Connecting sources in HT mode with no volume control could result in damage to hearing and/or speakers due to uncontrolled loud sounds.*

TAPE input

To use the **TAPE** input, connect external source to the **TAPE** input (see page 7). Select **TAPE** input by pressing the **TAPE** button so **TAPE** LED is lit. Selecting the **TAPE** input can also be achieved by pressing the corresponding button on the remote handset (see page 8).

BALANCED 1/HT input

To use the **BALANCED 1/HT** input as a standard input, connect balanced source outputs to the **BALANCED 1/HT** input XLR sockets (see page 7). Select the **BALANCED 1/HT** input by pressing the **BALANCED 1/HT** button so **BALANCED 1/HT** LED is lit. Selecting the **BALANCED 1/HT** input can also be achieved by pressing the corresponding button on the remote handset (see page 8).

To use the **BALANCED 1/HT** input as an HT input, move the **BAL/HT** switch to the HT position. This input is now unaffected by the volume control, allowing volume control on an external Home Theatre processor to be used directly. Connect Home theatre or other source outputs to the **AUX** input XLR sockets (see page 7). Select **BALANCED 1/HT** input by pressing the **BALANCED 1/HT** button so **BALANCED 1/HT** LED is lit.

***IMPORTANT:** Take great care when using the input in HT mode. Ensure that the volume control is turned right down on the HT processor when first setting up. The HT mode is designed for sources which require their own volume control to be used. Connecting sources in HT mode with no volume control could result in damage to hearing and/or speakers due to uncontrolled loud sounds.*

BALANCED 2 input

To use the **BALANCED 2** input, connect balanced source outputs to the **BALANCED 2** input XLR sockets (see page 7). Select the **BALANCED 2** input by pressing the **BALANCED 2** button so **BALANCED 2** LED is lit. Selecting the **BALANCED 2** input can also be achieved by pressing the corresponding button on the remote handset (see page 8).

TAPE MONITOR button and TAPE OUT

To record to tape, CD recorder, DAT, minidisk or computer soundcard analogue input, connect the tape out to the recorder line in. Press the input selector button on the front panel or remote control. This source will now be routed to the M8 PREAMPLIFIER **TAPE OUT** for recording by tape deck.

The recording can be directly monitored through the loudspeakers by pressing the **TAPE MONITOR** button so the **TAPE MONITOR LED** is lit. Press again to return back to the original input being listened to (and **TAPE MONITOR LED** is out again).

On some 3 head tape decks there is an additional tape/source switch which should be in the 'TAPE' position for this to work. If in doubt, please consult tape deck operating manual.

Note – the M8 PREAMPLIFIER volume control has no effect on the TAPE OUT signal.

Basic problem-solving with an amplifier is similar to troubleshooting other electrical or electronic equipment. Always check the most obvious possible causes first, such as the following examples:

Problem	Probable Cause	Remedy
No power when POWER button is pressed.	Mains power plug is not fully inserted into rear socket.	Plug in securely.
No sound	Mute function is still active. Wrong connections between input sources and the unit Outputs not connected, or incorrectly wired	Press the MUTE button on the remote control to cancel. Check audio input lead connections. Check output cables.
Sound cut	Loose connection	Check output and input connections.
Hum.	Audio connector plug not fully pushed in Cable Fault Unsuitable cable (e.g. cable grounds not connected)	Insert plug securely. Check cable is connected at both ends. N.B. Some esoteric cables have internal wiring intentionally disconnected/modified. For best results on all inputs analogue AND digital, please use good quality screened coax; signal and screens both separately connected at both ends.
No audio output, or too low level output.	Incorrect or missing connections	Check connections and make sure they are secure.
Remote control does not work.	Amplifier's POWER switch is set to off. One or more batteries fitted the wrong way round. Batteries are flat. Remote control is not pointed directly towards the front panel of the amplifier. Interference from another source.	Set switch to on. Insert batteries correctly. Change batteries for a new set. Ensure there is no obstruction between the remote control and amplifier front. Lighting such as fluorescent, incandescent, or even sunlight contains large amounts of infra red radiation. Ensure such sources are not shining directly on the infra red window as this could swamp the signal from the remote control. Also check the system and any other nearby remotes for stuck buttons.
Remote control range has greatly reduced	Batteries are running out	Change batteries for a new set.

If none of these actions affect a cure, please contact the dealer, or an authorised Musical Fidelity service agent. Remember; never open the case of the M8 Preamplifier, as this will invalidate the guarantee.

Output

Voltage

RCA single ended

9.5Vrms
26V peak to peak
47Ω

XLR balanced

19Vrms
52V peak to peak
47Ω

Output impedance

Line inputs

THD+N, 20Hz to 20 kHz
Signal / noise ratio
Input sensitivity for full output (vol. max)
Input impedance
Overload margin
Channel separation
Frequency response

<0.005%
>118dB 'A'-weighted
352mV
75KΩ
12dB
>96dB
+0, -1dB, 5Hz to 100 kHz

<0.004%
>118dB 'A'-weighted
352mV
150KΩ
12dB
>96dB

Phono inputs

Input sensitivity
Frequency response
Signal / noise ratio
Input impedance
Overload margin

3.5mV (MM) 440μV (MC)
RIAA/IEC see graph
81dB 'A'-weighted
47KΩ
29dB

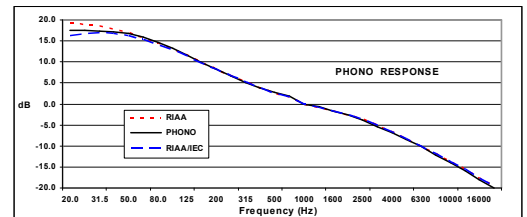

Connections

Phono MM/MC inputs

1 pair MM/MC (switchable) level RCA connectors

Line inputs

2 pairs line level XLR (balanced) connectors
5 pairs line level RCA connectors

Line outputs

1 pair line level RCA connectors, constant level TAPE REC outputs
1 pair line level XLR (balanced) connector outputs
1 pair line level RCA connector outputs

Power requirement

Mains voltages

115/230VAC 50/60Hz (factory pre-set)
100VAC 50/60Hz (alternative)

Consumption

25 Watts

Weight

Unit only, unboxed
In shipping carton

17 kg (37½ lbs)
23 kg (50⅔ lbs)

Dimensions

Wide
High, including feet
Deep (front to back) including terminals

440mm (17⅓")
162mm (6⅜")
400mm (15¾")

Standard accessories

IEC type mains lead (10-Amp type)
M8 Preamplifier remote control
Batteries, LR03 or AAA, manganese alkaline type - 2 off

Musical Fidelity reserves the right to make improvements which may result in specification or feature changes without notice.



RELEASE	DATE	CHANGES
Issue 1	21st February 2012	1 st issue
Issue 2	12 th April 2012	Weights and remote updated